

0 601 250 703

Stand | 03-01
Issue | 03-12-17

Fig./Abb. 1

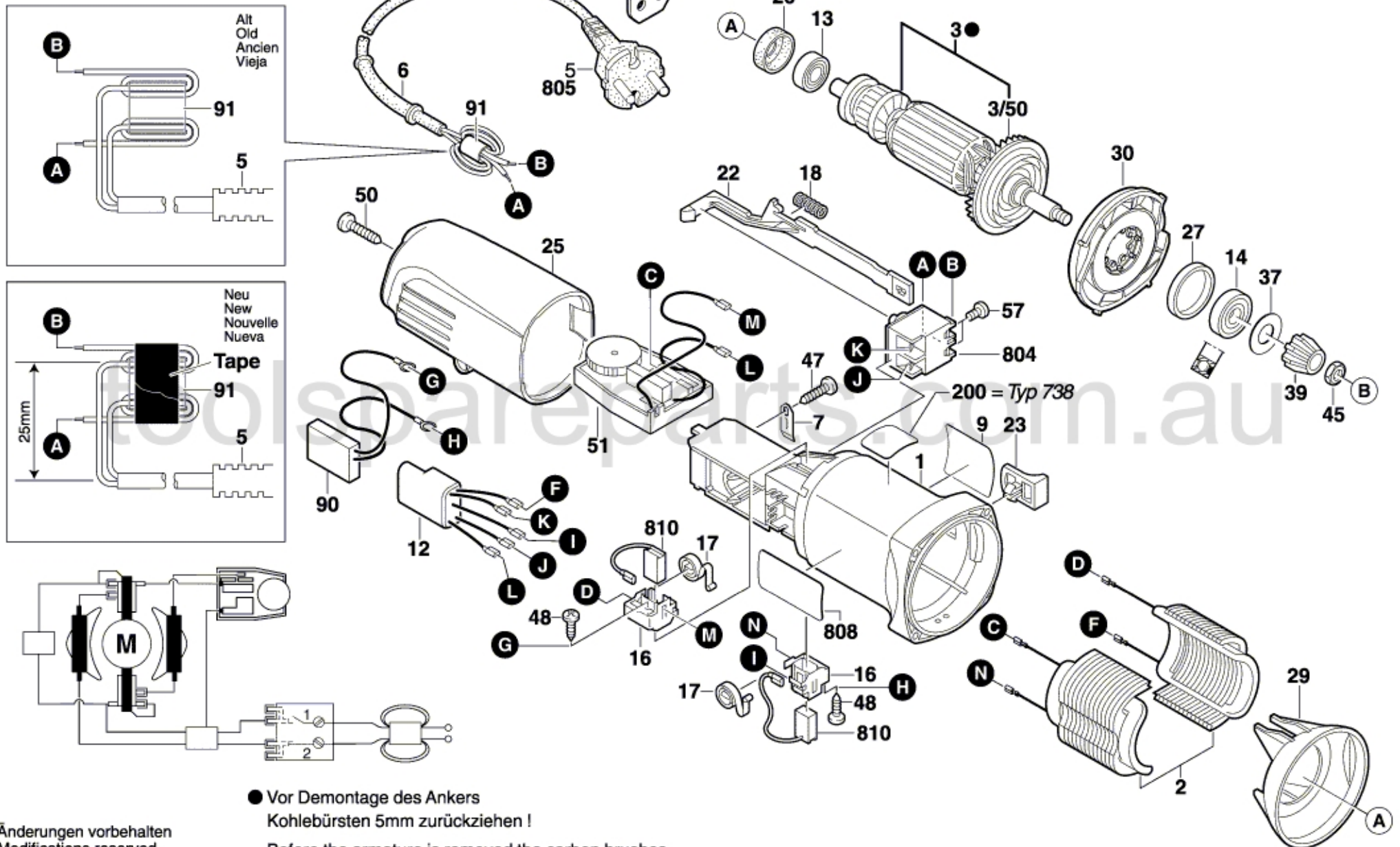

Änderungen vorbehalten
Modifications reserved
Modifications réservées
Salvo modificaciones